

Panasonic®

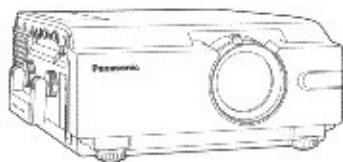

LCD PROJECTOR Operating Instructions Quick Reference Manual

Model No. **PT-L759U**

Table of Contents

Things You Should Know	2
Important Safeguards	3
Contents of LCD Projector Box	5
Product Information	6
Before using the Remote Control	8
<hr/>	
Standard Setting-up Positions	9
Adjusting the LCD Projector projection angle	10
System Configuration Example	11
Turning the power on and off	12
Setting-up Positions and Changing the Projection Mode	12
Digital Variable Compression	13
Keystone correction function	13
Changing the Input signal	14
Basic LCD Projector Operation	15
Adjusting the Picture to the Desired Setting	16
Adjusting the White Balance	16
Using Other Useful Functions	17
<hr/>	
Status Code Display Indications	20
Cleaning the Air Filter	21
Lamp Replacement	22
<hr/>	
Specifications	24
Before Requesting Service	25
Notes importantes concernant la sécurité	26
Utilisation de l'indicateur laser sur la télécommande	27
Remplacement de la lampe	27
Wichtige Sicherheitshinweise	29
Benutzung des Laserzeigers der Fernbedienung	30
Lampenaustausch	30

Please read these instructions completely before operating this LCD Projector.

This is a quick reference manual only. Please refer to the CD-ROM edition of the Operating Instructions for more detailed instructions.

Things You Should Know

Caution:

This equipment has been tested and found to comply with the limits for a Class B digital device, pursuant to Part 15 of the FCC Rules. These limits are designed to provide reasonable protection against harmful interference in a residential installation. This equipment generates, uses, and can radiate radio frequency energy and, if not installed and used in accordance with the instructions, may cause harmful interference to radio communications. However, there is no guarantee that interference will not occur in a particular installation. If this equipment does cause harmful interference to radio or television reception, which can be determined by turning the equipment off and on, the user is encouraged to try to correct the interference by one or more of the following measures:

- Reorient or relocate the receiving antenna.
- Increase the separation between the equipment and receiver.
- Connect the equipment into an outlet on a circuit different from that to which the receiver is connected.
- Consult the dealer or an experienced radio/TV technician for help.

FCC Warning:

To assure continued FCC compliance, use only the provided grounded power supply cord and prevent undesirable interference, use only the provided shielded VGA cable with 2 ferrite cores while connecting LCD to computer and all other connecting cables should be shielded. Any changes or modifications not expressly approved by the party responsible for compliance could void the user's authority to operate this equipment.

Warning:

To assure continued CE Mark compliance, use only the provided earthed power supply cord and prevent undesirable interference, use only the provided shielded VGA cable with 2 ferrite cores while connecting LCD to compliance could void the user's authority to operate this equipment.

Congratulations

On your purchase of one of the most sophisticated and reliable products on the market today. Used properly, we're sure it will bring you and your family years of service enjoyment. Please take time to fill in the information below. The serial number is on the tag located on the back of your LCD Projector. You'll want to keep this manual handy as your convenient LCD Projector information source. For your own protection and prolonged operation of your LCD Projector, please be sure to read the "Important Safeguards" carefully, before use.

Date of Purchase _____

Dealer Purchased From _____

Dealer Address _____

Dealer Phone No. _____

Model No. **PT-L759U**

Serial No. _____

© 2000 Matsushita Electric Industrial Co., Ltd

All product/brand names are trademarks or registered trademarks of the respective holders.

Important Safeguards



CAUTION:

Please read all of these instructions before you operate your LCD Projector. Save these instructions for future reference.

Electrical energy can perform many useful functions. This LCD Projector has been engineered and manufactured to meet applicable safety standards. But **IMPROPER USE CAN RESULT IN POTENTIAL ELECTRICAL SHOCK OR FIRE HAZARDS**. In order not to defeat the safeguards incorporated into this LCD Projector, observe the following basic rules for its installation, use and servicing.

- 1 Unplug the LCD Projector from the wall outlet before cleaning.
- 2 Do not use liquid cleaners or aerosol cleaners. Use a soft dry cloth to clean the LCD Projector unit. If the unit is very dirty, wet a cloth with neutral detergent, squeeze it tight, wipe the unit with it, and finish by wiping with a dry cloth. Do not use a chemical duster or polisher-cleaner because it can adversely affect the unit and peel the paint coat.
- 3 Do not use attachments not recommended by Panasonic, as they may cause hazards.
- 4 Do not use the LCD Projector near water; for example, near a bathtub, washbowl, kitchen sink, laundry tub, in a wet basement, near a swimming pool, etc. Never spill liquid into the LCD Projector.
- 5 Do not place the LCD Projector on an unstable cart, stand, or table. The LCD Projector may fall, which may cause serious injury to a child or an adult, and/or serious damage to the unit. Use only with a cart or stand recommended by its manufacturer, as being suitable for use with the LCD Projector.
- 6 Ceiling, wall or shelf mounting for installation should use a mounting kit approved by the manufacturer for use with the LCD Projector and should follow the manufacturer's instructions.
- 7 The LCD Projector equipment and cart combinations should be moved with care. Quick stops, excessive force, and uneven surfaces may cause the equipment and cart combination to overturn.
- 8 Slots and openings in the cabinet back and bottom are provided for ventilation. To ensure reliable operation of the LCD Projector and to protect it from overheating, these openings must not be blocked or covered. These openings should never be covered with cloth or other material. The bottom opening should not be blocked by placing the LCD Projector on a bed, sofa, rug, or other similar surface. The LCD Projector should not be placed near or over a radiator or heating vent. The LCD Projector should not be placed in a built-in installation such as a bookcase unless proper ventilation is provided.
- 9 The LCD Projector should be operated only from the type of power source indicated on the back of the LCD Projector or in the specifications. If you are not sure of the type of power supplied to your home, consult your LCD Projector dealer or local power company.
- 10 Do not allow anything to rest on the power cord. Do not place the LCD Projector where the cord will be walked on.
- 11 Follow all warnings and instructions marked on the LCD Projector.



- 12** As a safety feature, the LCD Projector is equipped with a 3-prong grounded plug. The 3-prong grounded plug will fit only into a grounding type power outlet. If the plug does not fit, use an adaptor that is properly grounded or have an electrician install a grounded type outlet. Do not attempt to modify this AC plug.
- 13** For added protection of the LCD Projector during a lightning storm, or when it is left unattended or not in use for long periods of time, unplug it from the wall outlet and disconnect any cable systems. This will prevent damage to the projector due to lightning and power-line surges.
- 14** Do not overload wall outlets and extension cords with too many products, because this can result in fire or electric shock.
- 15** Never push objects of any kind into the LCD Projector through cabinet slots as they may touch dangerous voltage points or short out parts, which could result in a fire or electric shock.
- 16** Do not attempt to service the LCD Projector yourself. Opening or removing covers may expose you to dangerous voltage or other hazards. Refer all servicing to qualified service personnel.
- 17** Unplug the LCD Projector equipment from the wall outlet and refer servicing to qualified service personnel under the following conditions:
 - A. When the power cord or plug is damaged or frayed.
 - B. If liquid has been spilled into the LCD Projector.
 - C. If the LCD Projector has been exposed to rain or water.
 - D. If the LCD Projector does not operate normally when you follow the operating instructions. Adjust only those controls that are covered by the operating instructions; improper adjustment of other controls may cause damage and will often require extensive work by a qualified technician to restore the LCD Projector to normal operation.
 - E. If the LCD Projector has been dropped or the cabinet has been damaged.
 - F. When the LCD Projector exhibits a distinct change in performance – this indicates a need for service.
- 18** Upon completion of any service or repairs to the LCD Projector, ask the service technician to perform a routine safety check to determine that the LCD Projector is in safe operating condition.
- 19** When replacement parts are required, be sure the service technician has used replacement parts specified by the manufacturer that have the same characteristics as the original parts. Unauthorized substitutions may result in fire, electric shock, or other hazards.
- 20** Air filter should be cleaned every 100 lamp on hours.
The LCD Projector may become too hot if filter is not cleaned when required.
- 21** If lens becomes dirty, or smudged, clean with a clean, dampened cloth. Never touch the lens with your fingers.
- 22** Do not look directly into the aperture and lens while operating as this may result in damage to your eyes.
- 23** Do not look into the red Laser Pointer transmitter, or aim the Laser beam at a person. Shining the Laser beam into the eyes could result in eye damage.

Contents of LCD Projector Box

Please confirm that the following items are packed in the LCD Projector box. They are provided to help you use or set up your LCD Projector.

- (1) LCD Projector
- (2) Remote Control unit (LRQ90044)
- (3) 2 "AA" Batteries
- (4) Lens Cap*
- (5) Carrying Handle*
- (6) 9.8 Foot UL/CSA Power Cord (VJAS0179)
- (7) VGA Cable (LSJA0239)
- (8) PS/2 Mouse Cable (LSJA0212)
- (9) MAC Mouse Cable (LSJA0214)
- (10) USB Cable (LSJA0305)
- (11) VGA MAC Adaptor (LSJA0307)
- (12) Audio Cable (LSJA0240)
- (13) Video Cable (LSJA0074)
- (14) CD ROM (Operating Instructions)
- (15) Warranty Card
- (16) Service Center List

*:Included with the projector

■ Load the 2 "AA" batteries in the Remote Control

- 1 Slide the lid in the direction of the arrow.

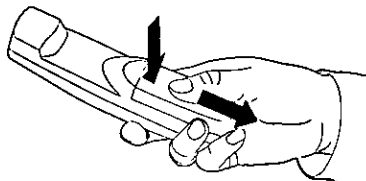

- 2 Install 2 "AA" batteries as indicated inside the Battery Compartment.

Battery replacement caution

- Do not mix old and new batteries.
- Also never mix alkaline with manganese batteries.

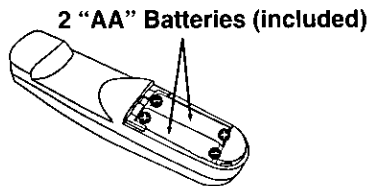

- 3 Replace the lid and snap into place.

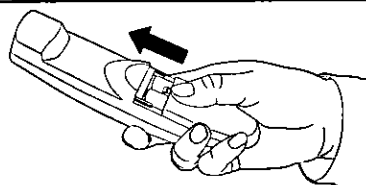

Product Information

Remote Control unit

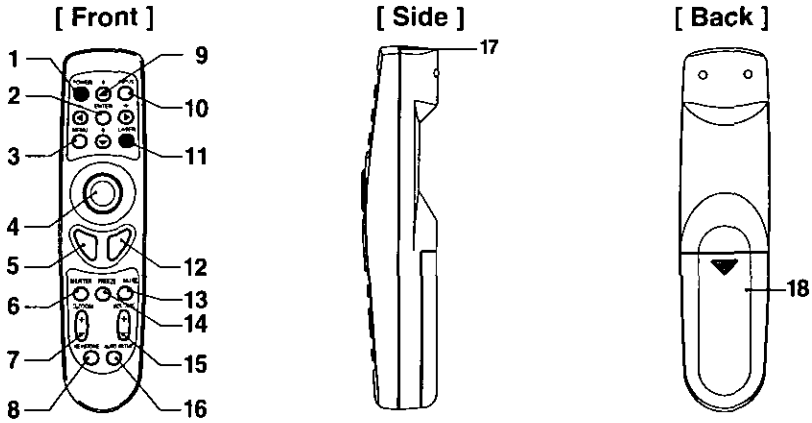

LCD Projector

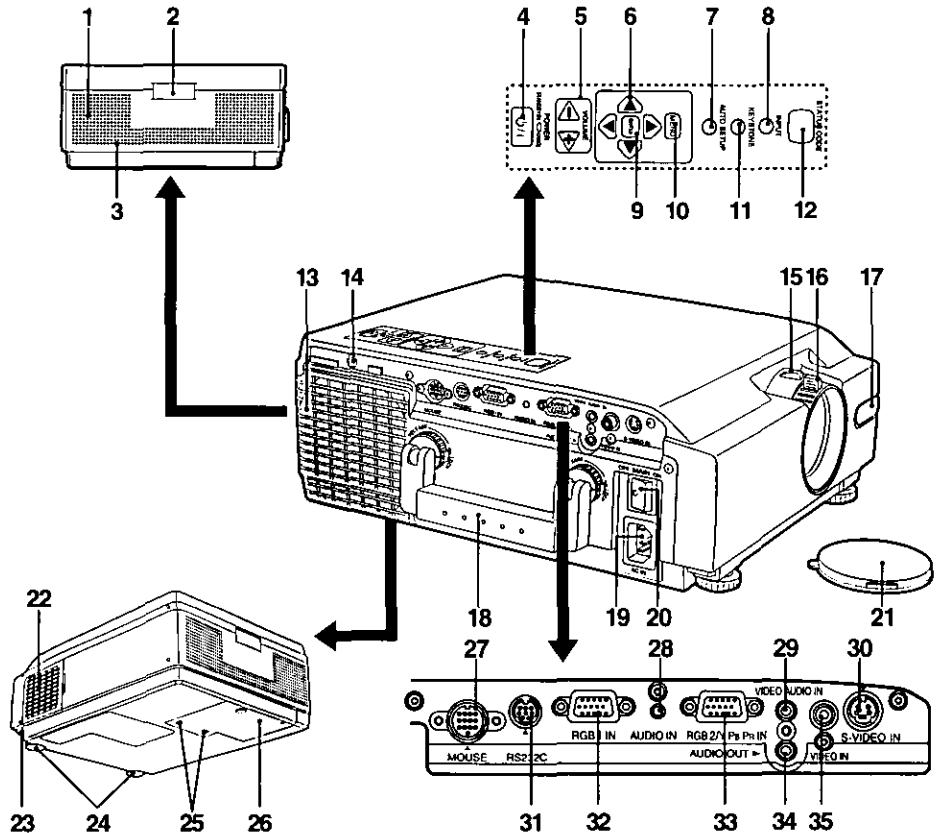

Remote Control unit

- 1 POWER Button
- 2 ENTER Button
- 3 MENU Button
- 4 Mouse Button*
- 5 Click 1 Button*
- 6 SHUTTER Button
- 7 D.ZOOM +/- Buttons
- 8 KEYSTONE Button
- 9 Adjust ▲▼◀▶ Buttons
- 10 INPUT Button
- 11 LASER Button
- 12 Click 2 Button*
- 13 MUTE Button
- 14 FREEZE Button
- 15 VOLUME +/- Buttons
- 16 AUTO SETUP Button*
- 17 Transmitter
- 18 Battery compartment

LCD Projector

- 1 Speaker
- 2 Remote Control Sensor
- 3 Security Lock
- 4 POWER Button/
POWER Indicator STANDBY(R) ON(G)
- 5 VOLUME +/- Buttons
- 6 Adjust ▲▼◀▶ Buttons
- 7 AUTO SETUP Button
- 8 INPUT Button
- 9 ENTER Button
- 10 MENU Button
- 11 KEYSTONE
- 12 STATUS CODE
- 13 Air outlet port
- 14 USB connector*
- 15 Zoom Ring
- 16 FOCUS Ring
- 17 Remote Control Sensor
- 18 Carrying Handle
- 19 AC Socket (100 V - 240 V)
- 20 Main Power Switch
- 21 Lens Cap
- 22 Air Filter
- 23 Adjuster Button
- 24 Adjustable legs
- 25 Lamp Cover Screw
- 26 Lamp Cover
- 27 MOUSE Connector*
- 28 RGB Audio Input Connector*
- 29 Video Audio Input Connector
- 30 S-Video Input Connector
- 31 RS232C Connector*
- 32 RGB1 Input Connector*
- 33 RGB2/YPbPr Input Connector*
- 34 Audio Output Connector
- 35 Video Input Connector

*: These buttons and connectors are for RGB input use. Refer to the CD-ROM edition of the Operating Instructions for details.

MicroSaver and Kensington are registered trademarks of Kensington Technology Group. All product names mentioned in this document are trademarks or registered trademarks of their respective owners.

© 1998 Kensington Technology Group.

Kensington Technology Group
2885 Campus Drive
San Mateo, CA 94403, U.S.A

Phone : (650)572-2700
Fax : (650)572-9675

Before using the Remote Control

■ Using the Laser Pointer on the Remote Control

When the Laser beam is aimed at the screen, the Pointer is displayed on the screen.

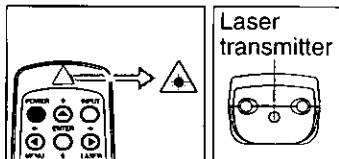

Press **LASER** on the remote control to activate Laser.

Warning

DO NOT look into the Laser transmitter, or aim the Laser beam at a person. Shining the Laser beam into the eyes could result in eye damage.

Note

- This product has the following laser radiation specifications: Wavelength - 650 nm, Max. Output - 1 mW, Class II (Class 2).

For U.S.A. only

- Class II laser products are normally required to be equipped with an indicator indicating that the laser beam is being emitted. On this product, the red beam emitted from the laser point functions as this indicator.
- Class II laser products are normally required to be equipped with an emergency stop device such as a shutter to stop the laser immediately. On this product, instead of such a device, the laser does not stay on unless the laser button is held in continuously.

CAUTION:

Use of controls or adjustments or performance of procedures other than those specified herein may result in hazardous radiation exposure.

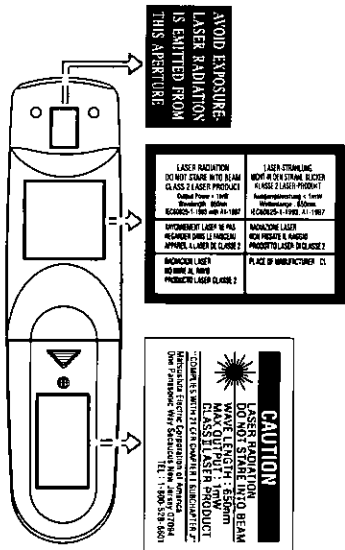

■ Operating range of the remote control unit

Point the remote control unit toward the remote control signal receptor on the front or the rear of the projector to operate the projector. Refer to the illustration below for the operating range of the remote control unit.

<Top view>

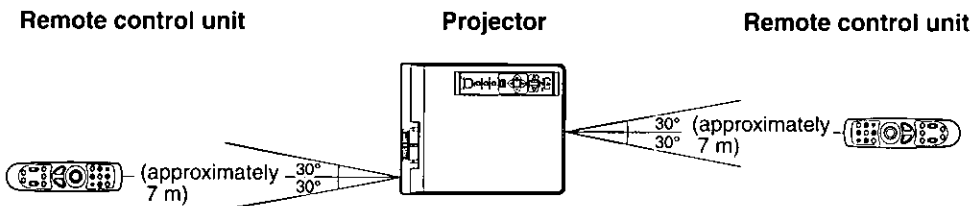

<Side view>

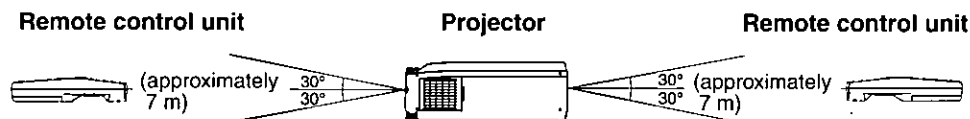

Standard Setting-up Positions

The screen should be positioned so that it is not directly touched by sunlight or room light as this will wash out the colors of the picture making it hard to see. When possible, close all blinds, curtains, etc. and dim the lights. Also, the LCD Projector should be at a 90° angle to the screen for the best picture results. To determine the distance for the desired size, please refer to the LCD Projector/Screen Relationship Chart below.

(By using the digital variable compression, you can increase the throw distance.)

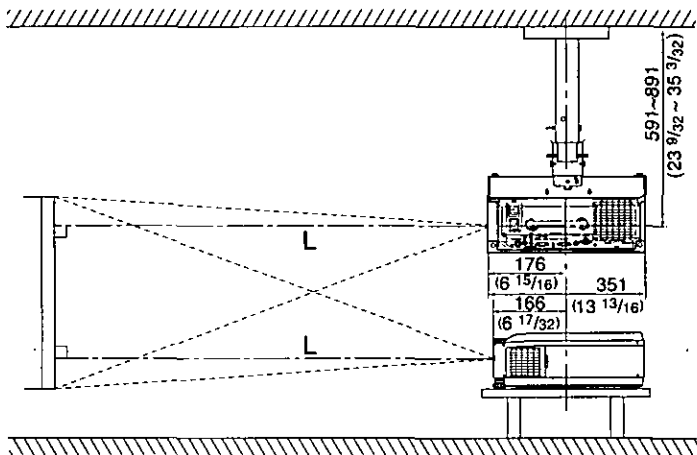

When installed using the ET-PK057 ceiling mount bracket (sold separately).

Unit : mm (inch)

- Your LCD Projector is equipped with an image reverse feature.

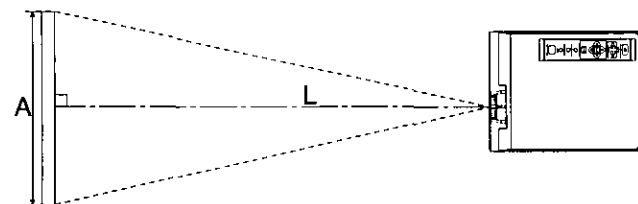

LCD Projector /Screen Relative Position Chart

The picture can be adjusted to the desired size within the range of the zoom lens. (This chart is based on a reduction ratio of 1 time.) The values in the table are reference values.

Screen size	Throw distance (L)	Measure (A)
20 inches	0.85 m (2.79 ft)	0.41 m (1.33 ft)
40 inches	1.33 m - 1.75 m (4.36 ft - 5.74 ft)	0.81 m (2.67 ft)
60 inches	2.00 m - 2.65 m (6.66 ft - 8.69 ft)	1.22 m (4.00 ft)
80 inches	2.73 m - 3.55 m (8.96 ft - 11.65 ft)	1.63 m (5.33 ft)
100 inches	3.43 m - 4.45 m (11.25 ft - 14.60 ft)	2.03 m (6.67 ft)
120 inches	4.13 m - 5.35 m (13.55 ft - 17.55 ft)	2.44 m (8.00 ft)
150 inches	5.18 m - 6.70 m (16.99 ft - 21.98 ft)	3.05 m (10.00 ft)
200 inches	6.93 m - 8.85 m (22.74 ft - 29.36 ft)	4.06 m (13.33 ft)
250 inches	8.68 m - 11.20 m (28.48 ft - 36.75 ft)	5.08 m (16.67 ft)
300 inches	10.43 m - 13.45 m (34.22 ft - 44.13 ft)	6.10 m (20.00 ft)

- If the LCD Projector and the screen are not properly placed, the picture will be distorted producing a keystoned image as shown below.



Keystoned Image

Adjusting the LCD Projector projection angle

Adjusting the LCD Projection angle of the LCD Projector. When the projector is in the horizontal position, keystone correction is unnecessary and a correct image can be viewed.

• Adjustment procedure

- 1 Lift the front of the LCD Projector to the desired angle. While holding it in place, press the 2 adjuster buttons located under the right and left sides of the projector. When the buttons are pressed, the left and right adjustable legs will drop down until they reach the setting-up surface.

Note

- Do not release the buttons until both legs have reached the setting-up surface.

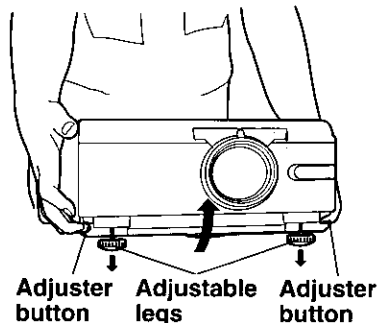

- 2 Release the adjuster buttons. (The adjustable legs will lock as soon as the buttons are released.)

- 3 Turn the adjustable legs by hand in either direction to make fine adjustments.

Note

- The legs can be extended by up to 52 mm. If you try to extend them any further than this, they will merely spin freely.

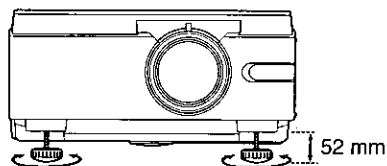

■ Retracting the adjustable legs

After lifting the front of the Projector slightly, press and hold the adjuster buttons and then gently lower the Projector.

Note

- Be sure to support the Projector firmly while pressing the adjuster buttons. If the adjuster buttons are pressed without supporting the Projector, the adjustable legs will suddenly unlock and the Projector will fall down, which could catch your fingers and damage the Projector.

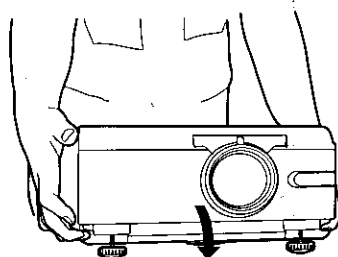

Caution: When you set up the LCD Projector

- Do not place it in humid or dusty places, or places where the air is sooty or full of cigarette smoke. If the lens, mirror, or other optical components become dirty, the picture will blur or darken, making viewing difficult.
- Do not expose to extreme heat or cold. Operating temperature: 5 °C – 40 °C (41 °F – 104 °F)

System Configuration Example

■ Example of connection to audio-visual equipment

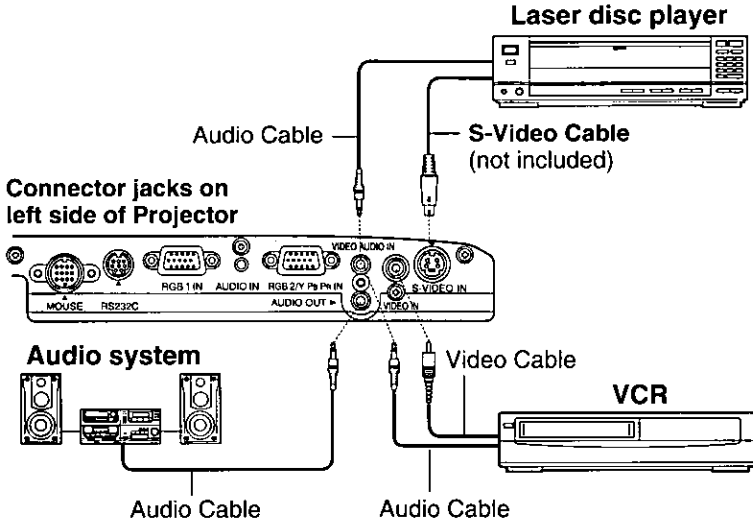

■ Example of connection to a computer

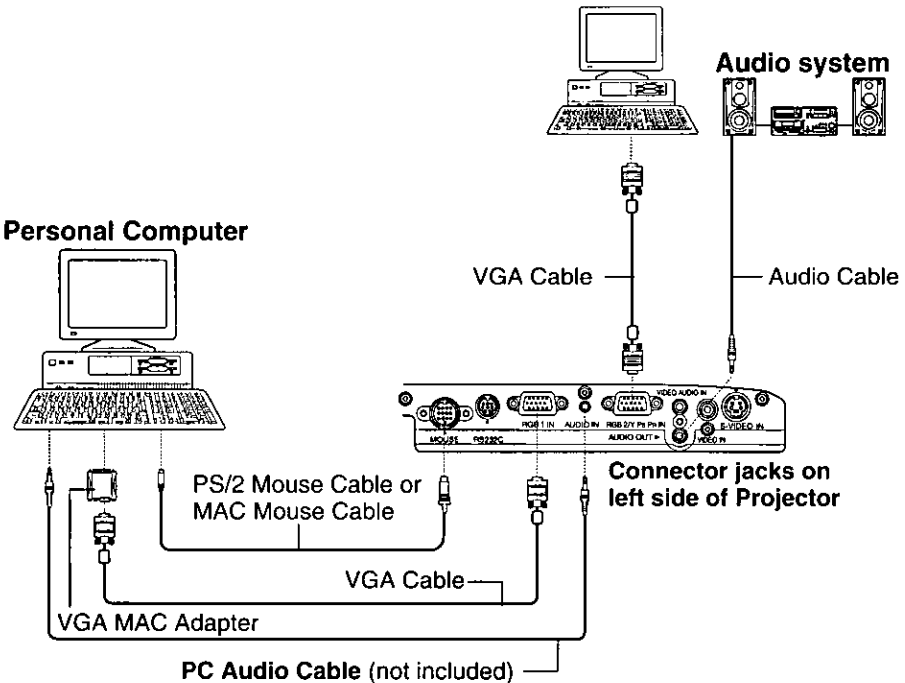

Turning the power on and off

• Turning on the power

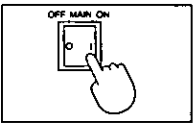
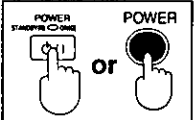
-  Press the **MAIN POWER switch** Press the **MAIN POWER switch** on the LCD Projector to ON.
↓
The power indicator will illuminate red and the Projector will switch to standby mode.
-  Press the **POWER button** Press the **POWER button** on the LCD Projector or remote control.
↓
The power indicator will illuminate solid green and a picture will be projected onto the screen.

• Turning off the power

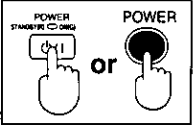
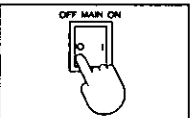
-  Press the **POWER button** Press the **POWER button** on the LCD Projector or remote control. "Please press POWER button again to power off" is displayed on the screen, and then press POWER button again.
↓
The power indicator will illuminate flashing red and the Projector will switch to standby mode.
- Wait for the cooling fan to stop. Wait for a while (approximately 60 seconds) until the cooling fan stops. (When the fan stops, the power indicator will illuminate solid red.)
-  Press the **MAIN POWER switch** Press the **MAIN POWER switch** on the LCD Projector to OFF.
↓
The power indicator will switch off and the power supply will be turned off.

Setting-up Positions and Changing the Projection Mode

• Setting procedure

- Press **MENU** to display the menu.
- Press **▲** or **▼** to select "Function", and then **ENTER** to display the screen.
- Press **▲** or **▼** to select "Projection Mode", and then **ENTER** to display the screen.

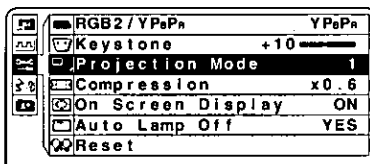
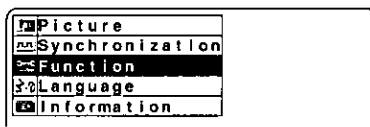

- Press **◀** or **▶** to select projecting mode from 1 to 4.
 - Select 1 DESK/Front (Factory setting)
 - Select 2 DESK/REAR (Right and Left displays in reverse)
 - Select 3 CEILING/REAR (Up and Down displays in reverse)
 - Select 4 CEILING/Front (Up and Down/Right and Left reverse display.)

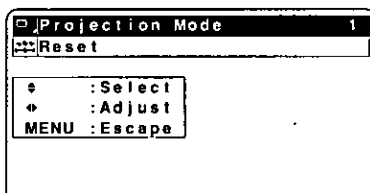

Digital Variable Compression

• Adjustment procedure

- 1 Press **MENU** to display the menu.
- 2 Press **▲** or **▼** to select "Function", and then **ENTER** to display the screen.

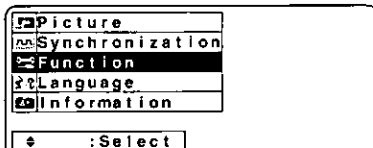

- 3 Press **▲** or **▼** to select "Compression", and then **ENTER** to display the screen.

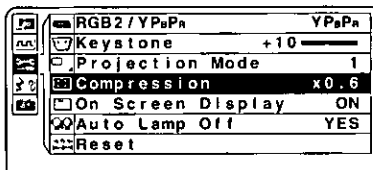

- 4 Press **◀** or **▶** to adjust the compression.
 - Image can be reduced up to 0.6.
 - When the number of dots of projected image corresponds with 832 X 624, 800 X 600, or 640 X 480, the image dimensions are displayed.
 - When the input signal dot number corresponds with the projected image, the image dimensions are displayed in colored letter.

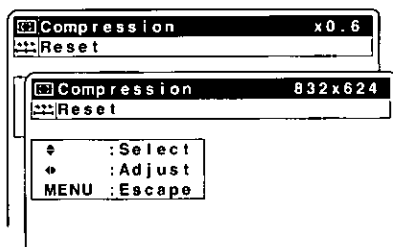

Keystone correction function

• Adjustment procedure

- 1 Press **MENU** to display the menu.
- 2 Press **▲** or **▼** to select "Function", and then **ENTER** to display the screen.

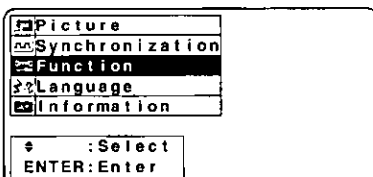

- 3 Press **▲** or **▼** to select "Keystone", and then **ENTER** to display the screen.

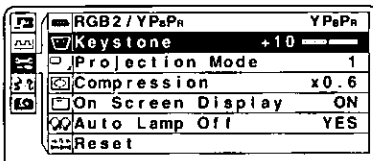

- 4 Press **◀** or **▶** to adjust the Keystone.

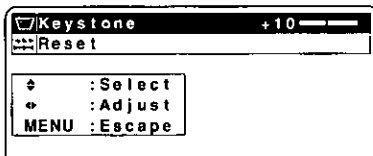

Changing the input signal

Press the INPUT button

(LCD Projector)

(Remote Control
unit)

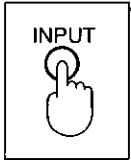

or

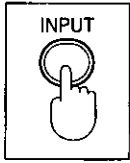

The input source for picture signals and the corresponding audio signals can be changed by pressing the INPUT buttons on the Projector operating panel or on the remote control.

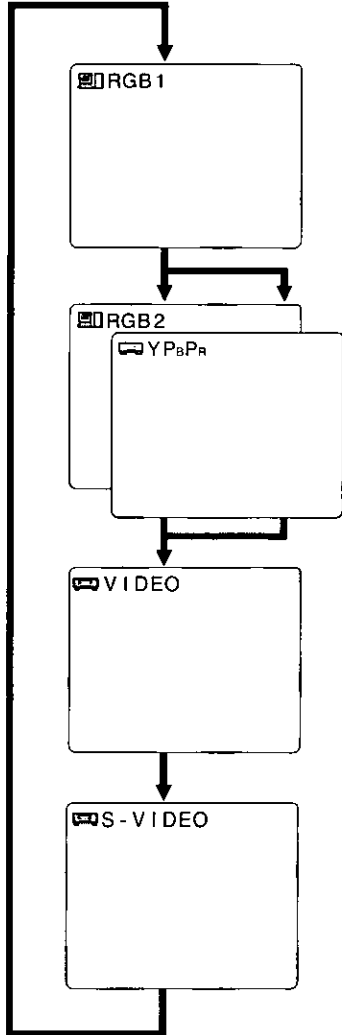

The signal from the source which is connected to the RGB1 connector is projected. This terminal accepts input of RGB input signals from a personal computer and DTV Format signals (RGB) from a DVD or a digital broadcast.

The signal from the source which is connected to the RGB2/YPbPr connector is projected. This terminal accepts input of RGB input signals from a personal computer and DTV Format signals (RGB, YPbPr) from a DVD or a digital broadcast. No monitor or Projector can automatically decide whether a Component signal is the RGB-type or the YPbPr-type. So, you will have to select either RGB or YPbPr manually.

The signal from the source which is connected to the VIDEO IN connector is projected.

The signal from the source which is connected to the S-VIDEO IN connector is projected.

Basic LCD Projector Operation

■ Adjusting the Volume

The volume can be adjusted using the VOLUME +/- on the LCD Projector or remote control unit.

(Remote Control unit)

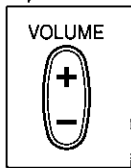

(LCD Projector)

or

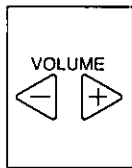

- Press **VOLUME +** to turn the volume high.
- Press **VOLUME -** to turn the volume low.

Note

- The "Volume" will remain displayed on the screen for approximately 5 seconds.

■ Turning off the sound

If the MUTE button on the remote control unit is pressed, "Mute" will be displayed on the screen as shown in the illustration below and the sound will be muted. If the MUTE button is pressed once more, the on-screen display will be cleared and the normal sound volume will be restored.

(Remote Control unit)

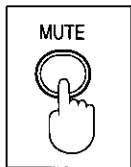

Note

- If the Power supply is turned off or either of the VOLUME +/- buttons is pressed, the mute setting will be canceled.

■ Turning off the Picture and Sound at the same time

When SHUTTER is pressed on the remote control unit the picture and sound turns off and the screen goes black. Press SHUTTER again to resume picture and sound.

(Remote Control unit)

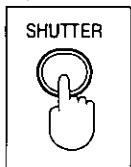

Note

- When the screen goes black, the picture will not be shown on the screen. However, the picture continues to be sent from the Personal Computer or video source.

■ Freezing the picture

Projection can be switched between a frozen (still) picture and a moving picture each time when the FREEZE button on the remote control is pressed. Press FREEZE button again to resume motion.

(Remote Control unit)

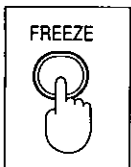

Note

- The sound is muted while the picture is frozen.

Adjusting the Picture to the Desired Setting

• Adjustment procedure (when adjusting the Color)

- 1 Press **MENU** to display the menu.
- 2 Press **▲** or **▼** to select "Picture", and then **ENTER** to display the screen.

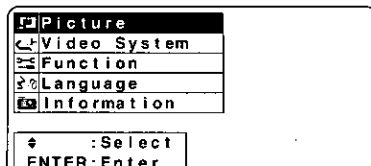

- 3 Press **▲** or **▼** to select "Color", and then **ENTER** to display the Color individual adjustment screen.

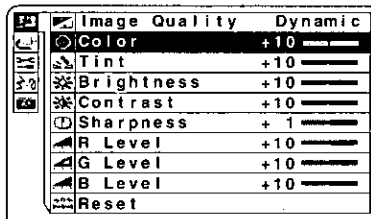

- 4 Press **◀** or **▶** to adjust the color.
 - The current setting will be displayed on the screen by numerals and a bar.

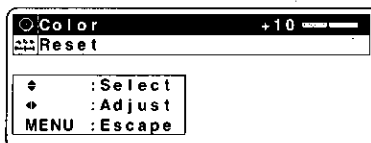

Note

The Tint, Bright, Contrast and Sharpness settings can also be adjusted at the same time.

Adjusting the White Balance

• Adjustment procedure (for white balance adjustment of the red component)

- 1 Press **MENU** to display the menu.
- 2 Press **▲** or **▼** to select "Picture", and then **ENTER** to display the screen.

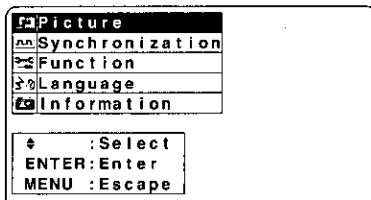

- 3 Press **▲** or **▼** to select "R Level", and then **ENTER** to display the R Level individual adjustment screen.

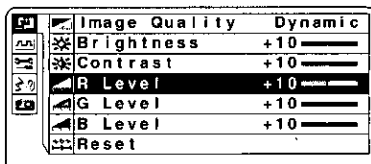

- 4 Press **◀** or **▶** to adjust the R Level setting.
 - The current setting will be displayed on the screen by numerals and a bar.

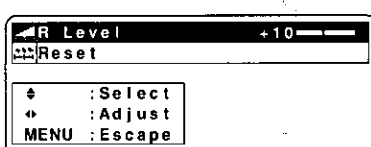

Note

The G Level and B Level settings can also be adjusted at the same time.

Using Other Useful Functions

■ Selecting the Language for On-Screen Displays

• Selecting procedure (select displays French)

- 1 Press **MENU** to display the menu.
- 2 Press **▲** or **▼** to select "Language", and then **ENTER** to display the screen.

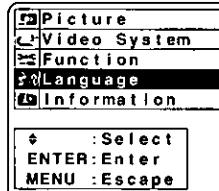

- 3 Press **▲** or **▼** to select "Français".
 - You can select English, German, French, Spanish, Italian, and Japanese.



■ Turning off the input signal display

• Selecting procedure

- 1 Press **MENU** to display the menu.
- 2 Press **▲** or **▼** to select "Function", and then **ENTER** to display the screen.

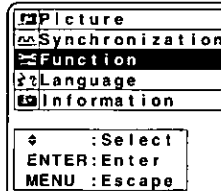

- 3 Press **▲** or **▼** to select "On Screen Display", and then **ENTER** to display the screen.

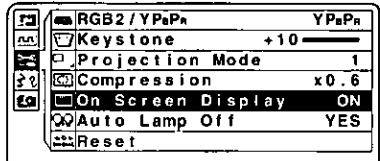

- 4 Press **◀** or **▶** to select "ON" or "OFF".
 - Select "OFF" to turn off the input signal display function.
 - Select "ON" to turn the input signal display function. The input signal will be displayed each time it is changed. (This is the factory setting.)

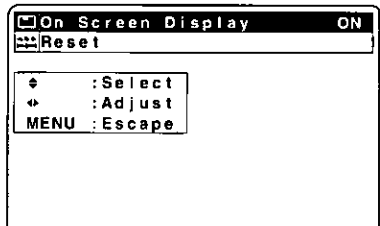

Using Other Useful Functions

■ Changing to 16:9 (wide) screen format

• Selecting procedure

- 1 Press **MENU** to display the menu.
- 2 Press **▲** or **▼** to select "Function", and then **ENTER** to display the screen.

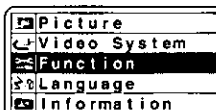

- 3 Press **▲** or **▼** to select "16 : 9", and then **ENTER** to display the screen.

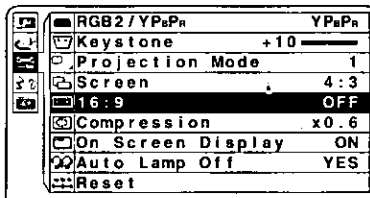

- 4 Press **◀** or **▶** to select "ON" or "OFF".
 - Select "OFF" to return the normal screen. (This is the factory setting.)
 - Select "ON" to display in 16:9 (wide) screen.

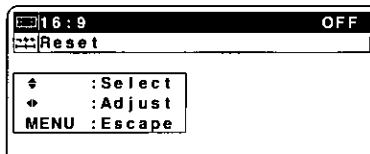

■ Auto Lamp Off

• Selecting procedure

- 1 Press **MENU** to display the menu.
- 2 Press **▲** or **▼** to select "Function", and then **ENTER** to display the screen.

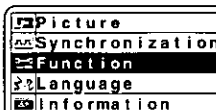

- 3 Press **▲** or **▼** to select "Auto Lamp Off", and then **ENTER** to display the screen.

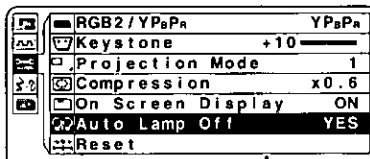

- 4 Press **◀** or **▶** to select "YES" or "NO".

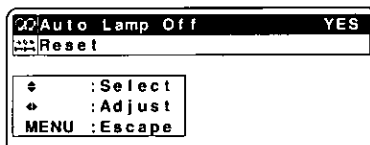

■ Setting the Screen Type (4:3↔16:9)

• Setting procedure

- 1 Press **MENU** to display the menu.
- 2 Press **▲** or **▼** to select "Function", and then **ENTER** to display the screen.

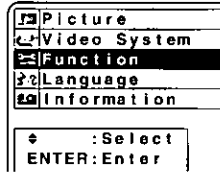

- 3 Press **▲** or **▼** to select "Screen", and then **ENTER** to display the screen.

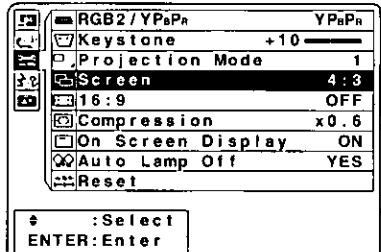

- 4 Press **◀** or **▶** to change the screen type (4:3↔16:9).
 - The 4:3 type screen is set at the factory.

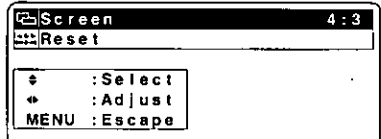

■ S-VIDEO/VIDEO Signal Format Selection

• Setting procedure

- 1 Press **MENU** to display the menu.
- 2 Press **▲** or **▼** to select "Video System", and then **ENTER** to display the screen.

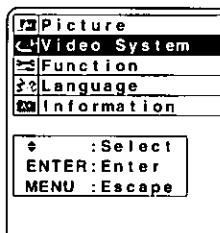

- 3 Press **▲** or **▼** to switch the setting to "AUTO", "NTSC", "NTSC4.43", "PAL", "PAL-M", "PAL-N" or "SECAM" until a normal picture is obtained.

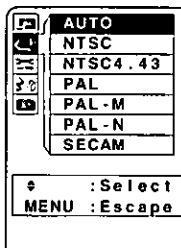

Status Code Display Indications

Warning Indicators

This LCD Projector has a STATUS CODE Display which calls your attention to problem conditions existing inside the LCD Projector. The LCD Projector displays a Status Code Indication each time an internal problem is detected.

If any of the following indications appear in the STATUS CODE Display, immediately turn off the Main Power switch, and then see the chart to determine a course of action.

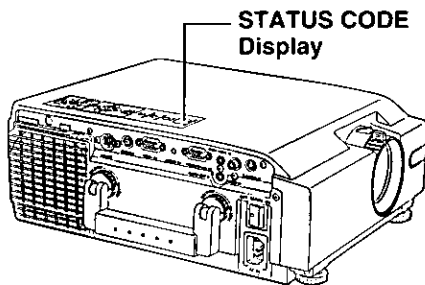

STATUS CODE	Symptom	Problem	Possible Solution
F-L	Lamp Unit automatically turns off due to abnormally high internal temperature. (Stand-by condition)	• Cooling fan malfunction.	• Take the Projector to your nearest Service Center.
F-0		• Misinstalled Air Filter Unit.	• Properly install Air Filter Unit.
A-n		• Temperature Sensor malfunction.	• Take the Projector to your nearest Service Center.
A-0		• Clogged air filter. • Blocked air intake. • The surrounding temperature of the place of use may be too high.	• Clean the filter. • Relocate projector to a proper location. • Place Projector so that surrounding temperature is between 5 °C (41 °F) and 40 °C (104 °F) and the humidity is between 10 % and 80 % (with no condensation).
L-n	Lamp does not light up.	• Lamp is burned-out.	• Take the Projector to your nearest Service Center.
P-2		• Lamp Voltage is not correct.	
P-3		• Abnormal temperature rise.	
P-4		• Other causes.	
L-1	Lamp operation time is over 1 900 hours.	• It is nearly time to replace the Lamp Unit.	• Replace the Lamp unit.
L-0	Lamp operation time is over 2 000 hours.	• The Lamp Unit must be replaced.	
C-d	Forced cooling fan operating to expedite lamp replacement.	—	—

Cleaning the Air Filter

Air Filter

The air filter should be cleaned about every 100 hours. Also, clean the air filter if the "A-0" is indicated in the STATUS CODE display. Replace the filter when it is clogged or dirty even after cleaning.

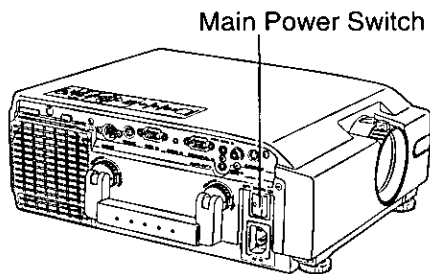

Cleaning procedure

Tools required: Vacuum Cleaner.

1 Set the Main Power Switch to OFF and unplug the power cord.

- Wait until the cooling fan stops and the STANDBY(R) ON(G) indicator turns solid red.

2 Place the LCD Projector up on its side as illustrated.

Note

- When transporting the PT-L759U, grasp the carrying handle and place in a flat, stable place.

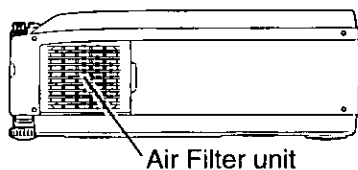

3 Remove the Air Filter unit.

Hold the indent on the Air Filter unit with your hands and pull the Air Filter unit out of the LCD Projector.

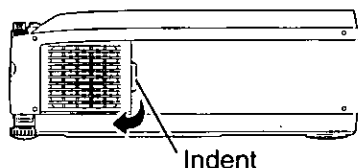

4 Clean the Filter.

Gently remove any accumulated dust from Air Filter unit with your vacuum cleaner.

CAUTION: Operating LCD Projector with torn or damaged Filter may cause damage to LCD Projector.

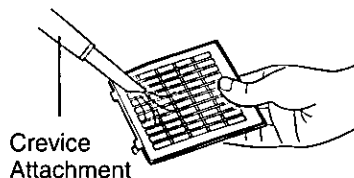

5 Replace the Air Filter unit.

Slide the Air Filter unit into the LCD Projector until hollows in the Air Filter unit are aligned with the hollows in the Projector.

Note

- The LCD Projector power cannot be turned on unless the Air Filter unit is correctly installed.
- Using with the air filter sponge removed will result in dirt and dust being drawn in and lead to malfunction.

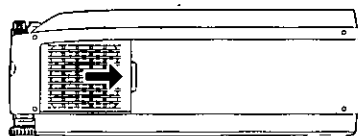

Note

- If the dust cannot be removed by cleaning, it is time to replace the air filter. Consult a sales outlet.

Lamp Replacement

Warning If Status Code "L-n" is displayed on the Status Code Display when lamp is not turned on, take the LCD Projector to your nearest Service Center for repair as there is danger of injury due to lamp fragments.

Lamp replacement period

The LCD Projector lamp has a limited operating life of approximately 2 000 hours.

If lamp operation time exceeds 1 900 hours, the operation time is displayed (at startup only) and "L-1" is displayed as the STATUS CODE.

"Lamp time remaining 10h" will be displayed on-screen when operation time reaches 1 990 hours.

Then, each time the power is turned on, the Lamp life remaining will be displayed.

- 15 second warning display (15 seconds when the LCD Projector power is turned on) will appear every 1 hour from 1 990 hours of operation time. And the warning will flash during the last 5 minutes of Lamp life.

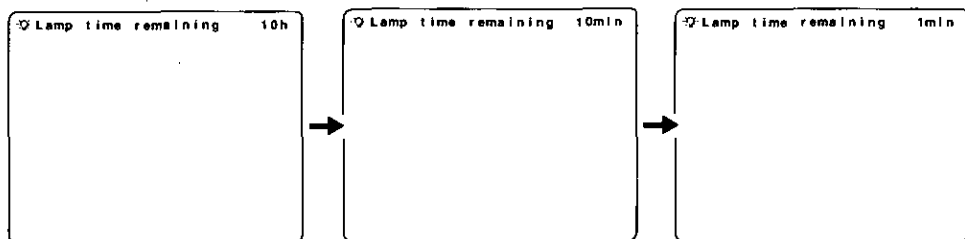
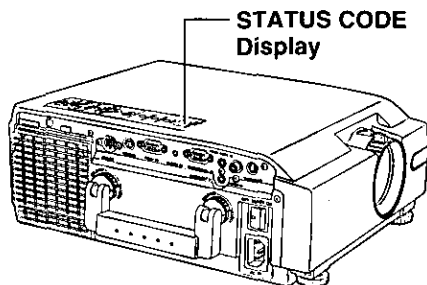

Note

- The lamp used as the light source eventually wears out. The service life of the light source lamp used on the PT-L759U is about 2 000 hours, but depending on the individual lamp's properties and the usage conditions the lamp may no longer light after less than 2 000 hours (the lamp is affected by the number of times the lamp is lit and the time span until it is relit, and these may shorten the service life). Because of this, we recommend having a replacement lamp on hand.

In case lamp use reaches 2 000 hours

The LCD Projector will shut itself OFF and the STATUS CODE indication becomes "L-0".

- If the Lamp is not replaced, turning POWER on will only cause the screen at right to be displayed for 5 minutes.

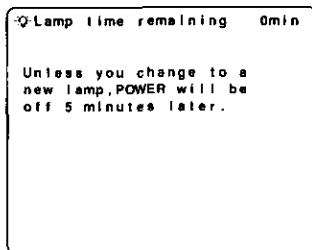

Note

- Replace the Lamps as described in steps 1-7 on page 23 and, please see the included separate sheet to perform the reset procedure.

■ Lamp replacement procedure

Caution: Because of possibility of injury, strictly follow the replacement procedure below.
Order Lamp ET-LA059.

1 After the cooling fan has stopped, and STANDBY(R) ON(G) indicator turns solid red. Set the Main Power Switch to OFF and unplug the power cord.

Note

- Please wait more than one hour for lamp replacement.

[If you need to replace the lamp more urgently]

- The LCD Projector has a forced cooling feature. After the POWER switch is turned OFF, and sometime during about the first minute of the normal cooling fan operation, press ◀ and ▶ at same time. The cooling fan will change to high speed for about 10 minutes. (The "C-d" STATUS CODE will be displayed.)

2 Grabbing the handle, place the LCD Projector up on its side as illustrated.

Note

- When transporting the PT-L759U, grasp the carrying handle and place in a flat, stable place.

3 Remove the Lamp cover screws.

First read caution and warning labels on Lamp cover. Then, remove the Lamp cover screws (2) by using screw driver, and take off the lamp cover.

4 Remove the Lamp unit screws.

Remove the lamp unit screws (2), then grasp the Lamp unit handle and carefully pull it from the LCD Projector. Keep Lamp housing opening to your right. Do not touch Lamp or point Lamp opening at anyone.

WARNING: The lamp may be hot. Be careful when handling.

CAUTION: • High-pressure lamp may be explode if improperly handled.
• Danger of injury due to lamp fragments.

5 Install the new Lamp unit.

Remove the Lamp ET-LA059 from the LCD Projector and install a new lamp unit (ET-LA059.)

- Do not drop, impact of dropping may cause Lamp to explode.

6 Replace the Lamp unit screws.

Replace the Lamp unit screw and the Lamp cover screws using a screwdriver to tighten.

- Properly dispose of old Lamp.

Note

- Attach the lamp unit and lamp unit housing door securely. If the lamp unit and lamp unit housing door are not attached securely, the protective circuit will be activated and the power will not turn on.

7 Plug the LCD Projector back in by inserting Power cord in LCD Projector AC socket and set the Main Power Switch to ON.

8 For lamp replacement, please see the included separate sheet to perform the reset procedure.

Specifications

LCD panels		1.3" Poly silicon LCD panel(W/MLA) X 3, RGB shutter method, using Translucent TN crystal panels
Drive method		Active Matrix 4:3 Aspect Ratio panels, TFT (Thin Film Transistor)
No. of pixels ¹		786 432 (1 024 X 768) stripe pixels X 3 panels
Lens		1 -1.3 zoom lens, F2.0 - 2.5, 145 mm - 59 mm Manual Focus
Projector lamp		220 W UHM Lamp
Contrast ratio		250 : 1
Brightness		2 500 lumen / ANSI
No. of colors		16 777 216
Screen size		0.508 m (20") - 7.620 m (300") (measured diagonally)
Projection (throw) distance		0.85 m (2.62') - 13.45 m (44.29')
Lens axis shift		6 : 1 Low position
Color systems		PAL/SECAM/NTSC/PAL-M/PAL-N/NTSC4.43
Video input signal		1 V [p-p], sync negative, 75 Ω terminated
S-Video input signal		Y (luminance signal) : 1 V [p-p], sync negative, 75 Ω terminated C (chrominance signal) : burst 0.286 V [p-p], 75 Ω terminated
RGB1 input signal	Video signal	RGB Analog (0.7 V [p-p], 1.0 V [p-p] with sync on green, 75 Ω) YPbPr (Y: 1.0 V [p-p], Pb, Pr: 0.7 V [p-p], 75 Ω)
	Sync signal	H/V separate, H/V composite, or Sync-on-Green
RGB2/YPbPr input signal	H-Frequency	24 KHz - 110 KHz (TTL Level)
	V-Frequency	50 Hz - 86 Hz (TTL Level)
Connectors		S-Video Input: Mini DIN 4-pin X 1 Video Input : RCA pin X 1 Video Audio Input: M3 stereo mini pin X 1 Serial Port (RS-232C): Mini DIN 8-pin X 1 MOUSE Port: 13-pin round connector X 1 RGB2/YPbPr Input: D-Sub mini 15-pin X 1 RGB/YPbPr Audio Input: M3 stereo mini pin X 1 RGB1 Input: D-Sub mini 15-pin X 1 Audio output: M3 stereo mini pin X 1 USB 4-pin X 1 (Type B)
Controls	Cabinet Buttons/ Switches	Main Power ON/OFF, Power ON/OFF, Volume +/-, Auto setup, Menu, Input, ▲, ▼, ◀, ▶, Enter, Keystone
	Remote Control Buttons	Power ON/OFF, Freeze, Shutter, Mute, Volume +/-, Enter, Menu, Input, ▲, ▼, ◀, ▶, Laser, D.Zoom +/-, Keystone, Auto setup, Mouse, Click 1, Click 2
Audio output		1.5 W (10 % THD)
Speaker		70 mm X 40 mm X 1 (2.76" X 1.58" X 1)
Operating Temperature		41 °F to 104 °F (5 °C to 40 °C)
Operating Humidity		10 % - 80 % (non-condensing)
Storage Temperature		-13 °F to 104 °F (-25 °C to 40 °C) 104 °F to 140 °F (40 °C to 60 °C)
Storage Humidity		5 % - 85 % (non-condensing) Normal humidity
Power Supply		100 V - 240 V AC (50 Hz or 60 Hz) Automatic
Power consumption		370 W
Dimensions W x H x D		263 mm X 124 mm X 336 mm (10 - 6/16" X 4 - 14/16" X 13 - 4/16")
Amps		3.7 A - 1.5 A
Weight		13.9 lbs. (6.3 kg)
Approvals		FCC, UL, C-UL, CE, VDE, FDA

Before Requesting Service

If the LCD Projector unit fails, check the following before calling your dealer for service.

Problem	Possible Cause
Power does not turn on.	<ul style="list-style-type: none">• The power cord may not be connected.• The main power switch on the projector may be turned off.• The main power supply may not be supplied to the wall outlet.• The Status Codes are indicated on the STATUS CODE Display.• The lamp unit or lamp unit cover may not have been correctly installed.• The Air Filter Unit may not have been correctly installed.
No picture appears.	<ul style="list-style-type: none">• The lens cap may still be attached to the lens.• The signal input source may not be connected properly.• The input selection setting may not be correct.• The Brightness adjustment may be lowest setting.• The LCD Projector may be set to the Shutter mode.
The picture is fuzzy.	<ul style="list-style-type: none">• The lens focus may not have been set correctly, or the projector may not be at the correct distance from the screen.• The lens may be dirty.• The LCD projector may not be set up so that it is perpendicular to the screen.• The VIDEO or R, G, B adjustments may not have been set correctly.
"Focus" or "No Signal" appears on screen.	<ul style="list-style-type: none">• The signal input source may not be connected properly.• The input selection setting may not be correct.• The connected signal source may be turned off.
Color is too light or tint is poor.	<ul style="list-style-type: none">• Color or Tint adjustment may be incorrect.• The video formats may not match.• The signal cables may be connected incorrectly. For instance, the PB, PR connectors may be reversed.
No sound can be heard.	<ul style="list-style-type: none">• The audio signal source may not be connected properly.• The volume adjustment may be at the lowest possible setting.• The Mute function or Audio/Video Shutter function may be active.
Remote Control does not operate.	<ul style="list-style-type: none">• The batteries may be spent, or they may not be inserted correctly.• There may be an object blocking the infrared signals between remote control unit and the projector.• The remote control unit may be out of the operating range.
The color is black-and white.	<ul style="list-style-type: none">• The Video System may not be correct.

Notes importantes concernant la sécurité



ATTENTION: Lire toutes ces instructions avant d'utiliser votre projecteur. Conserver le mode d'emploi en lieu sûr afin de pouvoir le consulter ultérieurement.

Ce projecteur à affichage à cristaux liquides a été conçu et fabriqué pour répondre aux normes de sécurité en vigueur. Mais une **UTILISATION INCORRECTE PEUT PROVOQUER UNE DECHARGE ELECTRIQUE OU UN INCENDIE**. Afin de ne pas supprimer les protections incorporées dans ce projecteur à affichage à cristaux liquides, respectez les règles de base suivantes pour son installation, utilisation et réparation.

- 1 Débrancher le projecteur de la prise de courant murale avant d'entreprendre le nettoyage.
- 2 Ne pas appliquer des produits de nettoyage liquides ou des aérosols. Utiliser un chiffon doux et sec pour nettoyer le projecteur. Si le projecteur est très sale, tremper un chiffon dans un détergent neutre, bien essorer le chiffon, puis essuyer le boîtier et terminer en essuyant avec un chiffon doux. Ne pas utiliser un dépolisseur chimique ou un nettoyant lustrant parce qu'il risque de détériorer le boîtier et de décapier le revêtement de peinture.
- 3 Ne pas utiliser des accessoires non recommandés par Panasonic, car ils risquent de provoquer des dangers.
- 4 Ne pas utiliser le projecteur près de l'eau; par exemple, près d'une baignoire, un lavabo, un évier, une cuve à lessive, dans un sous-sol mouillé, près d'une piscine, etc. Ne jamais renverser de liquides dans le projecteur.
- 5 Ne pas placer le projecteur sur un chariot, un support ou une table instable. Le projecteur risque de tomber, ce qui pourrait provoquer des blessures graves à un enfant ou un adulte, et/ou endommager l'appareil. Utiliser uniquement avec un chariot ou un support recommandé par le fabricant et adapté à l'utilisation d'un projecteur à affichage à cristaux liquides.
- 6 Le montage au plafond, contre un mur ou sur une étagère doit se faire à l'aide d'un kit de montage agréé par le fabricant.
- 7 Le projecteur à affichage à cristaux liquides et le chariot doivent être déplacés avec soin. Des arrêts brusques, une force excessive et des surfaces inégales risquent de faire basculer l'équipement et le chariot.
- 8 Les fentes et orifices au dos et au fond du boîtier sont destinés à la ventilation. Afin de garantir un fonctionnement fiable du projecteur à affichage à cristaux liquides et de le protéger contre le surchauffement, ces orifices ne doivent pas être bloqués ou couverts. Ces orifices ne doivent jamais être couverts par un tissu ou un autre matériau. L'orifice du fond ne doit pas être bloqué en plaçant le projecteur à affichage à cristaux liquides sur un lit, un fauteuil, un tapis ou toute autre surface similaire. Le projecteur à affichage à cristaux liquides ne doit pas être placé près d'un radiateur ou sur le dessus ou près d'une cheminée. Le projecteur à affichage à cristaux liquides ne doit pas être encastré sauf si une ventilation correcte est assurée.
- 9 Le projecteur doit être utilisé uniquement avec le type de source d'alimentation indiquée au dos du projecteur ou dans les caractéristiques techniques.
En cas de doute sur le type d'alimentation électrique de votre entreprise, consulter le revendeur de votre projecteur à affichage à cristaux liquides ou la compagnie d'électricité locale.
- 10 Ne rien poser sur le cordon d'alimentation. Ne pas placer le projecteur à affichage à cristaux liquides dans un endroit où le cordon sera sur un lieu de passage.
- 11 Respecter les avertissements et instructions marqués sur le projecteur à affichage à cristaux liquides.
- 12 Par mesure de sécurité, ce projecteur est équipé d'une prise trois conducteurs avec mise à la terre. S'il n'est pas possible d'insérer la fiche dans la prise, utiliser un adaptateur ou confier l'installation d'une prise de terre à un électricien. Ne pas essayer de modifier cette fiche secteur.
- 13 Pour améliorer la protection du projecteur à affichage à cristaux liquides pendant un orage ou lorsqu'il est laissé sans surveillance ou inutilisé pendant une longue période, débranchez la fiche de la prise murale et débranchez tous les câbles. Cela évite d'endommager le projecteur par la foudre et les surtensions des lignes d'alimentation.
- 14 Ne pas surcharger les prises murales et les cordons de rallonge avec trop d'appareils car cela risque de provoquer un incendie ou une décharge électrique.
- 15 Ne jamais enfoncer d'objets de quelque sorte dans le projecteur à affichage à cristaux liquides par les fentes du boîtier, car ils pourraient toucher des points dangereux sous haute tension ou générer des court-circuits, qui risquent de provoquer un incendie ou une décharge électrique.
- 16 Ne pas essayer de réparer le projecteur à affichage à cristaux liquides soi-même. Ouvrir ou enlever les des couvercles risque de vous exposer à une tension dangereuse ou à d'autres dangers. Confiez tous travaux de dépannage à un dépanneur qualifié.
- 17 Débrancher le projecteur à affichage à cristaux liquides de la prise murale et confiez le dépannage à un dépanneur qualifié dans les conditions suivantes:
 - A. Lorsque le cordon d'alimentation ou la fiche est endommagée ou effilochée.
 - B. Si du liquide a été renversé dans le projecteur à affichage à cristaux liquides.
 - C. Si le projecteur à affichage à cristaux liquides a été exposé à la pluie ou à l'humidité.
 - D. Si le projecteur à affichage à cristaux liquides ne fonctionne pas normalement lorsque les instructions d'utilisation ont été suivies. Réglez uniquement les commandes décrites dans les instructions d'utilisation; un réglage incorrect des autres commandes risque de provoquer des dégâts et nécessiteront souvent un travail approfondi par un technicien qualifié pour remettre le projecteur à affichage à cristaux liquides en état de fonctionnement normal.
 - E. Si le projecteur à affichage à cristaux liquides a subi une chute ou si le boîtier a été endommagé.
 - F. Lorsque le projecteur à affichage à cristaux liquides présente un changement distinct dans sa performance - cela signifie une nécessité de réparation.
- 18 A la fin de tout entretien ou réparation du projecteur à affichage à cristaux liquides, demandez au technicien du service après-vente d'effectuer une vérification de sécurité de routine afin de déterminer si le projecteur à affichage à cristaux liquides est en état de fonctionnement.
- 19 Lorsque le remplacement des pièces est nécessaire, s'assurer que le technicien du service après-vente a utilisé les pièces de remplacements spécifiées par le fabricant et ayant les mêmes caractéristiques que les pièces d'origine. Des substitutions non autorisées risquent de provoquer un incendie, une décharge électrique ou d'autres dangers.
- 20 Le filtre à air doit être nettoyé toutes les 100 heures de fonctionnement de la lampe.
Le projecteur à affichage à cristaux liquides risque de devenir trop chaud si le filtre n'est pas nettoyé lorsque cela est nécessaire.
- 21 Si l'objectif est sale ou encrassé, le nettoyer avec un chiffon propre, mouillé. Ne jamais toucher l'objectif avec les doigts.
- 22 Ne pas regarder à travers l'ouverture et l'objectif pendant que le projecteur fonctionne, car cela risque de provoquer des lésions oculaires.
- 23 Ne regardez pas dans l'émetteur du faisceau laser rouge, ou ne dirigez pas le rayon vers quelqu'un. Braquer la rayon laser dans les yeux entrainer des blessures aux yeux.



Utilisation de l'indicateur laser sur la télécommande

Lorsque le rayon laser est dirigé à l'écran, l'indicateur est affiché sur l'écran.

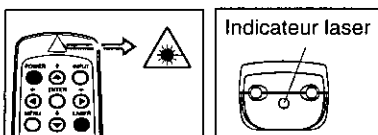

Appuyer sur LASER sur la télécommande pour activer le laser.

Avertissement

NE PAS regarder dans l'émetteur laser ni diriger le rayon laser vers une personne. Braquer le rayon laser dans les yeux peut entraîner des blessures aux yeux.

Remarque

- Les spécifications des radiations laser de ce produit sont les suivantes : Longueur d'onde - 650 nm, Sortie Max. - 1 mW, Classe 2:

Pour les U.S.A. seulement

- Les appareils laser de Classe 2 doivent normalement être équipés d'un indicateur précisant que le laser est émis. Sur cet appareil, le faisceau rouge émis du point de laser remplit la fonction de cet indicateur.
- Les appareils laser de Classe 2 doivent normalement être équipés d'un dispositif d'arrêt d'urgence tel qu'un obturateur pour couper immédiatement le laser. Sur cet appareil, au lieu d'un tel dispositif, le laser ne continue pas sans que le bouton laser soit maintenu enfoncé sans interruption.

ATTENTION: l'utilisation de commandes, de réglages ou l'exécution de procédures autres que celles spécifiées ici peut causer des expositions dangereuses aux radiations.

AVOID EXPOSURE
LASER RADIATION
IS EMITTED FROM
THIS APPLIANCE

LASER RADIATION
DO NOT STARE INTO BEAM
DO NOT DIRECT BEAM
AT OTHERS
CLASS 2 LASER PRODUCT
Maximum Power Output
0.5 mW at 650 nm
Wavelength 650 nm
Beam Diameter 1.5 mm

NEVER USE IN THE
SCENARIOS THAT IT IS INTENDED
UNLESS LASER IS OFF ?

NEVER POINT AT PEOPLE
NEVER POINT AT OTHERS ?

NEVER USE LASER
UNLESS LASER IS OFF ?

NEVER STARE INTO BEAM
DO NOT DIRECT BEAM
AT OTHERS ?

CLASS 2 LASER PRODUCT
Maximum Power Output
0.5 mW at 650 nm
Wavelength 650 nm
Beam Diameter 1.5 mm

CAUTION
LASER RADIATION
DO NOT STARE INTO BEAM
DO NOT DIRECT BEAM
AT OTHERS
CLASS 2 LASER PRODUCT
Maximum Power Output
0.5 mW at 650 nm
Wavelength 650 nm
Beam Diameter 1.5 mm

Remplacement de la lampe

Avertissement

Si le code de statut "L-n" apparaît sur l'affichage STATUS CODE (code de statut) lorsque la lampe n'est pas allumée, confiez les réparations du projecteur LCD à un centre de service car les fragments de lampe risquent de vous blesser.

Période de remplacement de la lampe

La lampe du projecteur LCD a une durée de service limitée de 2 000 heures environ.

"Durée lampe restante 10h" est affiché à l'écran, lorsque la durée de service atteint 1 990 heures.

Ensuite, chaque fois que le projecteur est allumé, la durée de vie restante de la lampe sera affichée.

- Un affichage d'avertissement de 15 secondes (15 secondes lorsque le projecteur LCD est allumé) apparaît toutes les heures à partir de la durée de service de 1 990 heures. Et l'avertissement clignote pendant les dernières 5 minutes de la durée de vie de la lampe.



- La lampe utilisée comme source lumineuse s'use éventuellement. La durée de vie de la lampe de source lumineuse utilisée sur le PT-L759U est environ de 2 000 heures, mais selon ses propriétés individuelles et les conditions de son utilisation la lampe peut ne plus éclairer après moins de 2 000 heures (la lampe est affectée par le nombre de fois où elle est allumée et par la période de temps jusqu'à ce qu'elle soit rallumée, et celles-ci peuvent raccourcir la durée de vie). Pour cette raison, nous recommandons d'avoir une lampe de rechange en main.
- Remplacer les lampes comme décrit dans les étapes 1-7 des pages 28 et lire la notice séparée fournie pour effectuer la procédure de réinitialisation.

■ Procédure de remplacement de la lampe

Attention: En raison des risques de blessures, procédez exactement de la manière décrite ci-dessous pour remplacer la lampe.

Commander la lampe ET-LA059.

- 1** Lorsque le ventilateur de refroidissement s'est arrêté, et l'indicateur **STANDBY(R) ON(G)** (attente(R)/mise sous tension) devient rouge, régler l'interrupteur principal sur **OFF** et débrancher le cordon d'alimentation.

Remarque: Attendre au moins une heure avant de remplacer la lampe.

{Pour un remplacement prématuré de la lampe}

- Le projecteur LCD possède une fonction de refroidissement forcé. Lorsque le commutateur de tension **POWER** est mis sur **OFF** (hors tension) et pendant environ la première minute du fonctionnement normal du ventilateur de refroidissement, appuyer sur ◀ et ▶ en même temps. Le ventilateur de refroidissement passe alors en vitesse rapide pendant 10 minutes. (Le **STATUS CODE "C-d"** est alors affiché.)

- 2** Tout en saisissant la poignée, placer le projecteur LCD debout sur son côté comme illustré.

Remarque

- En transportant le **PT-L759U**, saisissez la poignée de transport et déposez-le dans un endroit plat et stable.

- 3** Retirer les vis du couvercle de la lampe.

Lire d'abord les plaques de mise en garde et d'avertissement sur le couvercle de la lampe.

Ensuite, retirer les (2) vis du couvercle de la lampe avec une tournevis, et sortir le couvercle de la lampe.

- 4** Retirer la vis de l'unité de la lampe.

Retirer la vis (2) de l'unité de la lampe, puis saisir la poignée de la lampe et la sortir délicatement du projecteur LCD. Tenir l'ouverture du boîtier de la lampe à droite. Ne pas toucher la lampe et ne pas pointer l'ouverture de la lampe sur quelqu'un.

AVERTISSEMENT:	La lampe risque d'être chaude. Faire attention lors de sa manipulation.
-----------------------	---

ATTENTION:	<ul style="list-style-type: none">La lampe haute pression risque d'exploser si elle est utilisée incorrectement.Danger de blessures par les fragments de lampe.handled.
-------------------	--

- 5** Installer l'unité de la lampe neuve.

Retirer la lampe **ET-LA059** du projecteur LCD et installer une unité de lampe neuve (**ET-LA059**).

- Ne pas faire tomber la lampe, car le choc après une chute risque de faire exploser la lampe.

- 6** Remettre les vis de l'unité de la lampe en place.

Remettre la vis de l'unité de la lampe et les vis du couvercle de la lampe en place à l'aide d'une pièce de monnaie pour les visser.

- Éliminer la lampe usagée selon les prescriptions en vigueur.

Remarque

- Attachez solidement la lampe et la porte de logement de la lampe. Si la lampe et la porte de logement de la lampe ne sont pas jointes solidement, le circuit de protection sera lancé et la puissance ne s'allumera pas.

- 7** Rebrancher le projecteur LCD en insérant le cordon d'alimentation dans la prise **CA** du projecteur LCD et mettre l'interrupteur principal sur la position **ON** (marche.)

- 8** Pour le remplacement de la lampe, voir la notice séparée fournie pour effectuer la procédure de réinitialisation.

Wichtige Sicherheitshinweise



VORSICHT: Bitte lesen Sie sich diese Hinweise vor der Inbetriebnahme Ihres LCD-Projektors sorgfältig durch. Bewahren Sie die Bedienungsanleitung für spätere Referenznahme an einem sicheren Ort auf.

Elektrische Energie kann viele sinnvolle Funktionen ausführen. Dieser LCD-Projektor entspricht in seiner Entwicklung und Herstellung geltenden Sicherheitsstandards. Dennoch KANN EINE UNSACHGEMASSE BENUTZUNG EINEN ELEKTRISCHEN SCHLAG ODER BRAND VERURSACHEN. Um die in diesen LCD-Projektor eingebauten Sicherheitseinrichtungen nicht zu unterlaufen, beachten Sie bitte die nachfolgenden Grundregeln für die Installation, Benutzung und Wartung des LCD-Projektors.

- 1 Trennen Sie den LCD-Projektor vor der Reinigung von der Reinigung von der Netzsteckdose ab.
- 2 Verwenden Sie für die Reinigung keine Flüssig- oder Aerosolreiniger. Wischen Sie den LCD-Projektor mit einem weichen, trockenen Tuch ab. Befeuchten Sie das Tuch im Falle einer hartnäckigen Verschmutzung mit einem neutralen Reiniger, wringen Sie das Tuch fest aus, reinigen Sie das Gerät und wischen Sie mit einem trockenen Tuch nach. Reinigen Sie das Gerät weder mit einem chemischen Tuch noch mit einem Poliermittel, da derartige Reinigungsmittel das Gerät angreifen und ein Ablättern der Farbe verursachen können.
- 3 Verwenden Sie ausschließlich von Panasonic empfohlene Zubehörtteile, da die Benutzung anderer Zubehörtteile Gefahren mit sich bringt.
- 4 Betreiben Sie den LCD-Projektor nicht an Orten, an denen er mit Wasser in Berührung kommen könnte, z.B. in der Nähe einer Badewanne, eines Waschbeckens, einer Spüle, in feuchten Räumen, in der Nähe eines Schwimmbeckens usw.. Schützen Sie niemals Wasser in den LCD-Projektor.
- 5 Stellen Sie den LCD-Projektor nicht auf einem wackeligen Wagen, Stativ oder Tisch auf. Der LCD-Projektor könnte herunterfallen und sowohl Kinder als auch Erwachsene ernsthaft verletzen und/oder schwerwiegende Beschädigungen des Gerätes verursachen. Benutzen Sie ausschließlich vom Hersteller empfohlene und für diesen LCD-Projektor geeignete Wagen oder Stative.
- 6 Benutzen Sie für die Decken-, Wand- oder Schrankmontage einen vom Hersteller geprüften und für diesen LCD-Projektor als geeignet befundenen Montagesatz und nehmen Sie den Einbau entsprechend der Herstellerhinweise vor.
- 7 Der LCD-Projektor, dessen Zubehör und der Wagen müssen mit Vorsicht bewegt werden. Schnelle Stopps, übermäßige Anwendung von Gewalt und unebene Flächen können zu einem Umkippen des Gerätes und des Wagens führen.
- 8 Schlitze und Öffnungen in der Gehäuserückwand und dem Gehäuseboden dienen zur Belüftung. Für einen sicheren Betrieb des LCD-Projektors und zum Schutz vor Überhitzung dürfen diese Öffnungen weder blockiert noch abgedeckt werden. Legen Sie niemals ein Tuch oder einen anderen Gegenstand auf diese Öffnungen. Die Öffnung im Gehäuseboden darf nicht dadurch blockiert werden, daß Sie den LCD-Projektor auf ein Bett, Sofa, eine Decke oder ähnliche Unterlage stellen. Ferner sollte der LCD-Projektor nicht in der Nähe oder über einem Heizkörper oder Heizlüfter platziert werden. Stellen Sie den LCD-Projektor auch nicht in einen Bücherschrank, da dort keine ausreichende Belüftung gewährleistet ist.
- 9 Der LCD-Projektor darf nur von dem auf der Rückseite des Projektors oder in den technischen Daten aufgeführten Netzquellentyp aus betrieben werden. Wenn Sie Fragen zu den an Ihrem Arbeitsplatz herrschenden Spannungsverhältnissen haben, setzen Sie sich bitte mit Ihrem Verkäufer in Verbindung, bei dem Sie das Gerät erworben haben oder Ihren LCD-Projektorhändler oder fragen Sie bei den örtlichen Stadtwerken nach.
- 10 Legen Sie keine Gegenstände auf das Netzkabel und verlegen Sie das Kabel so, daß niemand darauf treten kann.
- 11 Beachten Sie alle auf dem LCD-Projektor aufgeführten Warnungen und führen Sie die Anweisungen aus.
- 12 Zur Sicherheit ist dieser LCD-Projektor mit einem dreistufigen Erdungsstecker ausgestattet. Der dreistufige Erdungsstecker paßt nur in eine für die Erdung ausgelegte Netzsteckdose. Sollte der Stecker nicht passen, benutzen Sie bitte einen Adapter, der ordnungsgemäß geerdet ist oder beauftragen Sie einen Elektriker mit der Installation einer geerdeten Steckdose. Versuchen Sie nicht, diesen Wechselstromstecker in irgendeiner Weise zu verändern.
- 13 Trennen Sie sowohl den Netzstecker von der Netzsteckdose ab als auch sämtliche Kabelsysteme für den zusätzlichen Schutz des LCD-Projektors im Falle eines Gewitters, bei Abwesenheit oder bei einer Nichtbenutzung des Gerätes über einen längeren Zeitraum hinweg. Dies verhindert Beschädigungen am LCD-Projektor bei Gewitter und Spannungsschwankungen in der Netzeleitung.
- 14 Überlasten Sie weder Netzsteckdosen noch Verlängerungskabel mit zu vielen Geräten, da dies einen Brand oder elektrischen Schlag verursachen könnte.
- 15 Schieben Sie keinerlei Gegenstände durch die Gehäuseschlitze in den LCD-Projektor. Die Gegenstände könnten gefährliche Spannungspunkte berühren oder Teile kurzschließen, was wiederum einen Brand oder elektrischen Schlag verursachen könnte.
- 16 Versuchen Sie nicht, den LCD-Projektor selbst zu warten. Das Öffnen oder Entfernen von Abdeckungen kann Sie gefährlichen Spannungen oder Gefahren aussetzen. Überlassen Sie sämtliche Wartungsarbeiten qualifiziertem Fachpersonal.
- 17 Trennen Sie die LCD-Projektoreinheit unter nachfolgend aufgeführten Umständen von der Netzsteckdose ab und ziehen Sie qualifiziertes Fachpersonal hinzu:
 - A. Wenn das Netzkabel oder der Netzstecker beschädigt oder durchgescheuert sind.
 - B. Wenn Flüssigkeit in den LCD-Projektor eingedrungen ist.
 - C. Wenn der LCD-Projektor Regen oder Wasser ausgesetzt worden ist.
 - D. Wenn der LCD-Projektor nicht ordnungsgemäß arbeitet, obwohl die Bedienung entsprechend der Bedienungsanleitung erfolgt. Stellen Sie nur die Bedienungselemente ein, die diese Bedienungsanleitung umfaßt; eine falsche Einstellung anderer Bedienungselemente kann Beschädigungen verursachen, die nur in einem aufwendigen Arbeitsgang von einem qualifiziertem Techniker behoben werden könnten.
 - E. Wenn der LCD-Projektor heruntergefallen oder das Gehäuse beschädigt ist.
 - F. Wenn der LCD-Projektor eine deutliche Änderung der Leistungsfähigkeit aufweist - dies ist ein Anzeichen dafür, daß eine Wartung erforderlich ist.
- 18 Beauftragen Sie nach Durchführung sämtlicher Wartungs- und Reparaturarbeiten einen Kundendiensttechniker mit einer routinemäßigen Sicherheitsprüfung, um die Betriebssicherheit des LCD-Projektors sicherzustellen.
- 19 Sollten Ersatzteile benötigt werden, achten Sie darauf, daß der Kundendiensttechniker ausschließlich vom Hersteller angegebene Ersatzteile verwendet, die über dieselben Eigenschaften wie die Originalteile verfügen. Nicht zugelassene Ersatzteile können einen Brand oder elektrischen Schlag verursachen und andere Risiken darstellen.
- 20 Der Luftfilter muß nach jeweils 100-stündigem Lampenbetrieb ausgetauscht werden. Der LCD-Projektor kann sich überhitzen, wenn der Filter im Falle der Erfordernis nicht ausgetauscht wird.
- 21 Wenn das Objektiv schmutzig oder schmierig ist, reinigen Sie es mit einem sauberen, feuchten Tuch. Fassen Sie das Objektiv niemals an.
- 22 Schauen Sie während des Betriebes nicht direkt in das Gerät und in das Objektiv, da dies Augenschäden verursachen kann.
- 23 Nicht in den Laserzeiger-Sender gucken oder den Laserstrahl auf eine Person richten. Der Laserstrahl könnte sonst Augenschäden verursachen.
- 24 Wir sind bemüht Ihre Umwelt sauber und schadstofffrei zu erhalten. Darum bitten wir Sie das nicht mehr zu reparierende Gerät bei Ihren Händler oder einer Recycling Firma abzugeben. (Diese Vorsichtsmaßnahme gilt nur für Deutschland.)



Benutzung des Laserzeigers der Fernbedienung

Wenn man mit dem Laserstrahl auf die Leinwand zeigt, wird auf der Leinwand der Zeiger abgebildet.

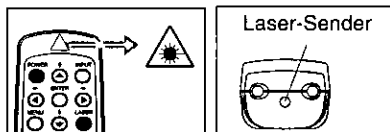

Zur Aktivierung des Lasers die **LASER-Taste** der Fernbedienung drücken.

Achtung

NICHT in den Laser-Sender gucken oder den Laserstrahl auf eine Person richten. Der Laserstrahl könnte sonst Augenschäden verursachen.

Hinweis

- Dieses Produkt besitzt folgende Laserstrahlungs-Spezifikationen: Wellenlänge - 650 nm, max. Ausgang - 1 mW, Klasse 2.

Nur für USA

- Klasse II Laserprodukte müssen normalerweise mit einer Anzeige ausgestattet sein, die anzeigt, daß der Laserstrahl emittiert wird. Bei diesem Produkt übernimmt der vorn, Laserpunkt emittierte rote Laserstrahl die Funktion dieser Anzeige.
- Klasse II Laserprodukte müssen normalerweise mit einer Notstopp-Einrichtung ausgestattet sein, wie einem Verschuß, damit der Laser sofort gestoppt werden kann. Anstelle solch einer Vorrichtung bleibt bei diesem Produkt der Laser nicht eingeschaltet, es sei denn, die Laser-Taste wird ununterbrochen gedrückt.

Achtung: Die Anwendung von Steuerungen oder Einstellungen oder die Ausführung von Verfahren, die nicht hier spezifiziert sind, können zu einer gefährlichen Strahlungsexposition führen.

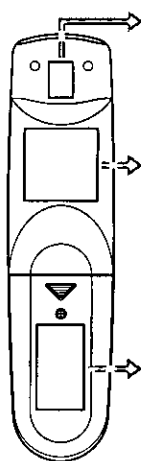

AVOID EXPOSURE-
LASER RADIATION
IS EMITTED FROM
THIS AREA



Lampenaustausch

Warnung

Falls bei nicht eingeschalteter Lampe auf dem STATUS CODE-Display der Statuscode "L-n" angezeigt wird, müssen Sie den Projektor zur nächsten Kundendienststelle zur reparatur bringen, weil Verletzungsgefahr durch Lampensplitter vorhanden ist.

Lampenaustauschperiode

Die Lampe des LCD Projektors hat eine begrenzte Betriebsdauer von ca. 2 000 Stunden. "Restlebensdauer lampe 10h" wird auf dem Bildschirm erscheinen, wenn die Betriebsdauer 1 990 Stunden erreicht hat. Dann wird, immer wenn der Strom eingeschaltet wird, die verbleibende Betriebsdauer angezeigt.

- Eine 15-sekündige Warnungsanzeige (15 Sekunden, wenn der LCD Projektor eingeschaltet wird) erscheint jede Stunde ab einer Betriebsdauer von 1 990 Stunden. Und die Warnung wird in den letzten 5 Minuten der Betriebsdauer blinken.

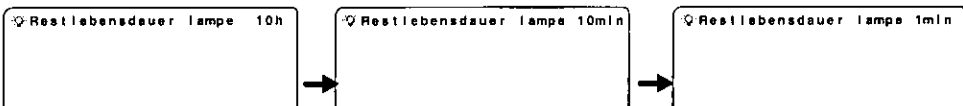

- Die als Lichtquelle verwendete Lampe kann unter Umständen verschleißen. Die Lebensdauer der im PT-L759U verwendeten Lichtquellenlampe beläuft sich auf etwa 2 000 Betriebsstunden. Abhängig von den individuellen Lampenwerten und den Benutzungsbedingungen kann sich die Lebensdauer jedoch auch verkürzen (die Lampe wird von der Leucht-Häufigkeit und der Zeitspanne zwischen den einzelnen Lampenbenutzungen beeinflusst, und kann ebenfalls eine Reduzierung der Lebensdauer zur Folge haben). Daher ist es empfehlenswert, stets eine Austauschlampe zur Hand zu haben.
- Tauschen Sie die Lampen wie in den auf den Seiten 31 beschriebenen Schritten 1-7 aus und beziehen Sie sich bitte auf das separat beigelegte Informationsblatt zur Durchführung des Rückstellungsbetriebes.

Lampenaustauschverfahren

Vorsicht: Wegen Verletzungsgefahr müssen die Anweisungen zum Austauschen strikt eingehalten werden.

Bestellen Sie die Lampe ET-LA059.

- 1** Nachdem das Kühlgebläse abgeschaltet ist und die **STAND BY(R) ON(G)-Anzeige** zu einem intensiven Rot wechselt. Stellen Sie den Netzschalter auf **OFF** und ziehen Sie das **Stromkabel** heraus.

Hinweis: Bitte warten Sie länger als eine Stunde für den Lampenaustausch.

[Wenn Sie die Lampe dringend austauschen müssen]

- Der LCD-Projektor besitzt eine focierte Kühlfunktion. Nachdem der Hauptschalter **POWER** auf **OFF** geschaltet ist, drücken Sie während der ersten Minute des normalen Betriebs des Kühlgebläses ◀ und ▶ gleichzeitig. Das Kühlgebläse arbeitet ca. 10 Minuten mit Hochgeschwindigkeit. (Der "C-d" STATUS CODE wird angezeigt.)

- 2** Halten Sie den Griff fest und stellen Sie den LCD Projektor, wie dargestellt, auf die Seite.

Hinweis

- Tragen Sie den PT-L759U beim Transport am Tragegriff und legen Sie ihn auf eine ebene, stabile Fläche.

- 3** Schrauben Sie die Lampenabdeckungsschrauben ab.

Lesen Sie zuerst die Vorsichts- und Warnungsaufkleber auf der Lampenabdeckung. Entfernen Sie dann mit der schraubendreher die Lampenabdeckungsschrauben (2) und nehmen die Lampenabdeckung ab.

- 4** Schrauben Sie die Lampeneinheitsschraube ab.

Schrauben Sie die Lampeneinheitsschraube (2) ab, greifen Sie den Lampeneinheitsschraubgriff und ziehen Sie sie vorsichtig aus dem LCD Projektor heraus. Lassen Sie das Lampengehäuse rechts von Ihnen geöffnet. Fassen Sie die Lampe nicht an oder zeigen Sie mit der Lampenöffnung auf niemanden.

WARNUNG: Die Lampe könnte heiß sein. Gehen Sie vorsichtig vor.

VORSICHT:

- Hochdruck-Lampen könnten bei falschem Umgang explodieren.
- Verletzungsgefahr durch Lampensplitter.

- 5** Lampeneinheitsschraube.

Nehmen Sie die Lampe ET-LA059 aus dem LCD Projektor heraus und installieren Sie eine neue Lampeneinheit (ET-LA059.)

- Lassen Sie sie nicht fallen, bei einem heftigen Aufprall kann die Lampe explodieren.

- 6** Schrauben Sie die Lampeneinheitsschrauben wieder an.

Schrauben Sie die Lampeneinheitsschraube und die Lampenabdeckungsschrauben mit der Münze wieder an.

- Richtige Entsorgung der alten Lampe.

Hinweis

- Die Lampeneinheit selbst sowie deren Tür müssen ordnungsgemäß befestigt sein. Wenn dies nicht der Fall ist, wird die Schutzschaltung aktiviert und das Gerät schaltet sich nicht ein.

- 7** Schließen Sie den LCD Projektor wieder an, indem Sie das Stromkabel in die **WS-Buchse (AC-Buchse)** des LCD Projektors stecken und den Netzschalter auf **ON** stellen.

- 8** Beziehen Sie sich bezüglich des Lampenaustausches bitte auf das separate Informationsblatt zur Durchführung des Rückstellungsbetriebes.

Panasonic®

Professional/Industrial Video

Panasonic Broadcast & Television Systems Company
Division of Matsushita Electric Corporation of America

One Panasonic Way 4E-7 Secaucus, NJ 07094 (201) 392-4443
3330 Cahuenga Blvd West Los Angeles, CA 90068 (323) 436-3500

Technical Support:

(800) 524-1448

(800) 526-6610

FAX: (201) 392-6514

E-Mail: pbtssupport@panasonic.com

Panasonic Canada Inc.

5770 Ambler Drive, Mississauga, Ontario L4W 2T3 (905) 624-5010